

Model	Rated Voltage V _{DC}	No Load		Rated Load			
		Current mA	Speed min ⁻¹	Load mN·m	Current mA	Speed min ⁻¹	
LM405	12.0	90	2800	20.0	600	2100	CCW
LM507	24.0	80	4300	20.0	480	3600	CCW
LM503	24.0	160	7400	12.0	820	7000	CCW
LM553	24.0	70	2800	25.0	400	2000	CCW ※16.3

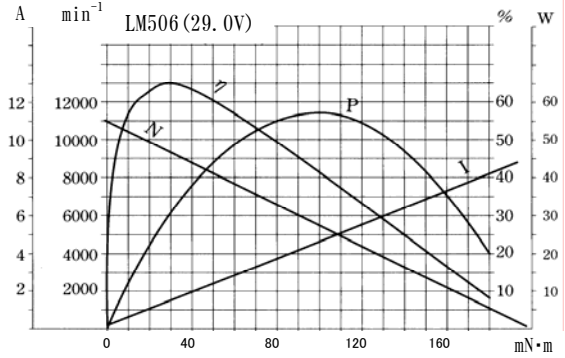

Model	Rated Voltage V _{DC}	No Load		Rated Load			CW/CCW	ℓ
		Current mA	Speed min ⁻¹	Load mN·m	Current mA	Speed min ⁻¹		
LM408	12.0	100	2600	20.0	560	2000	CW	11.5
LM410	12.0	300	4500	30.0	1500	3300	CW	16.0
LM519	24.0	260	11000	10.0	800	10500	CCW	16.0
LM506	29.0	240	11000	20.0	1200	9800	CW	11.5

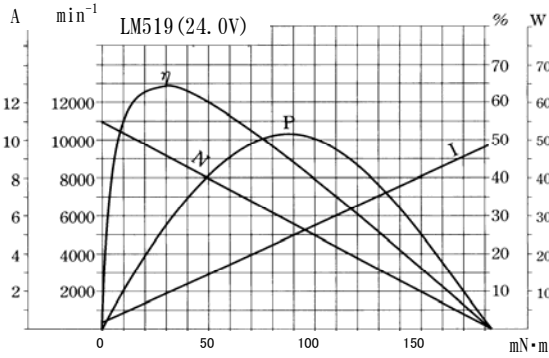
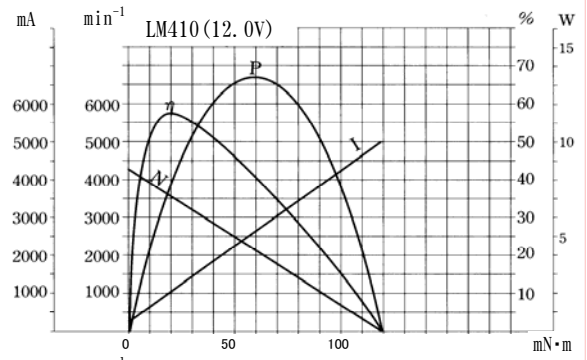
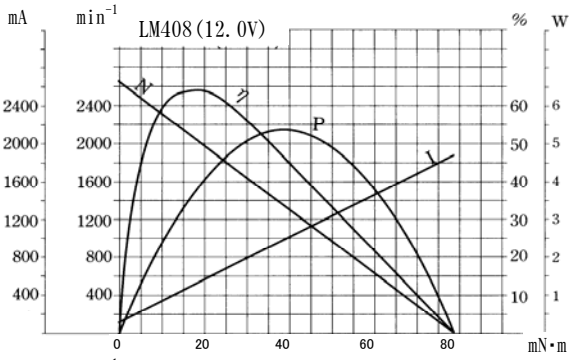
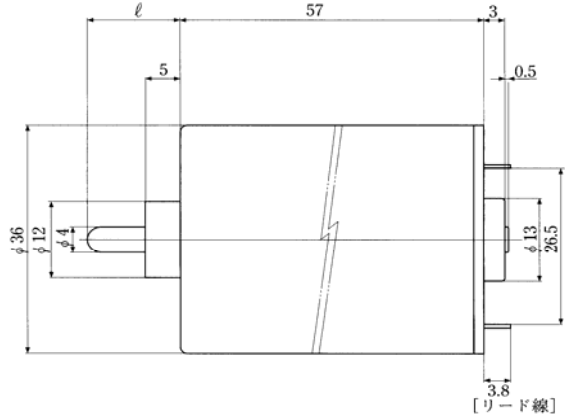
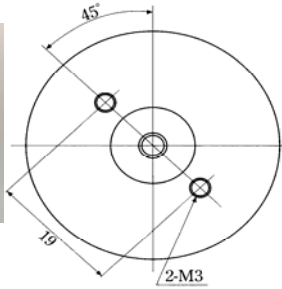
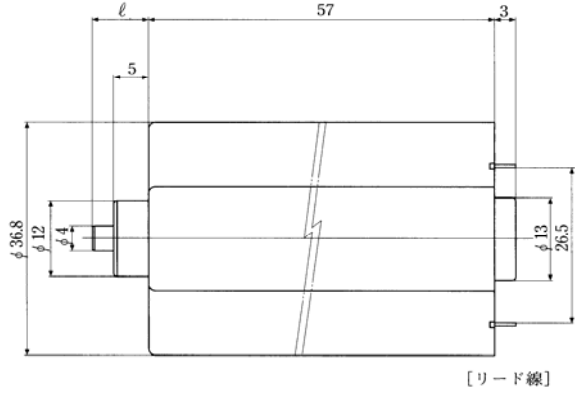
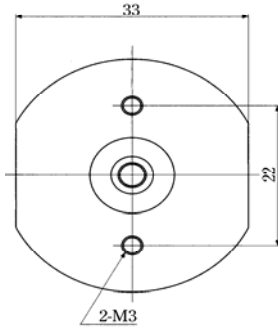

[リード線]

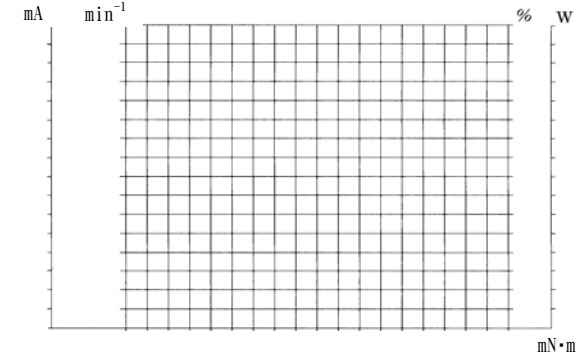
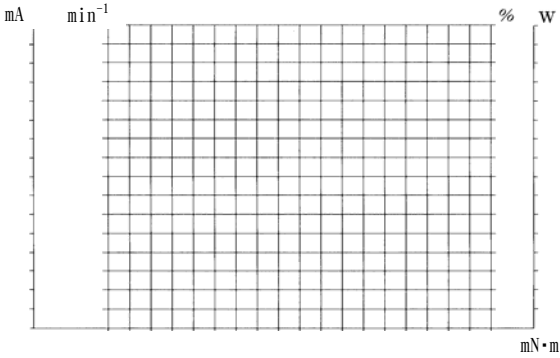
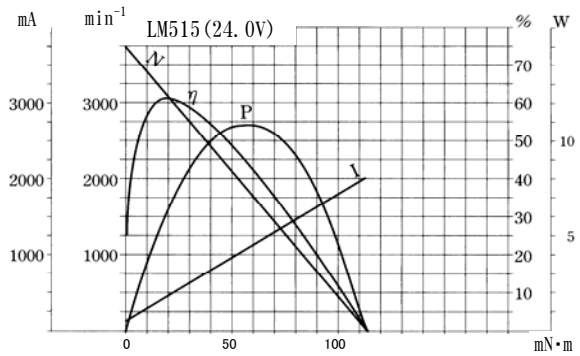
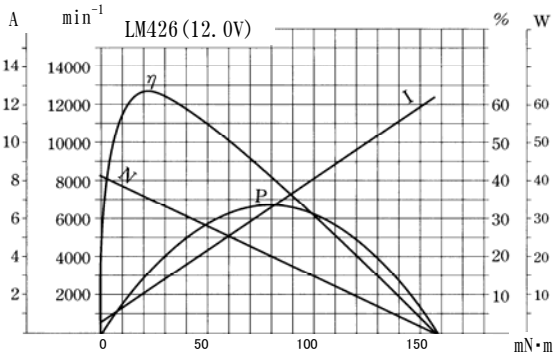

Model	Rated Voltage V _{DC}	No Load		Rated Load				
		Current mA	Speed min ⁻¹	Load mN·m	Current mA	Speed min ⁻¹		ℓ
LM334	7.2	4000	21500	20.0	12000	20000	CCW	20.0
LM426	12.0	600	8200	30.0	3400	6600	CW	20.6
LM515	24.0	120	3800	20.0	450	3100	CCW	12.0